

Nr	Ausmaß			St
1	894	299	18	2
2	894	299	18	2
3	263	278	15	4
4	300	300	18	2
5	263	298	15	2
6	892	277	2	2

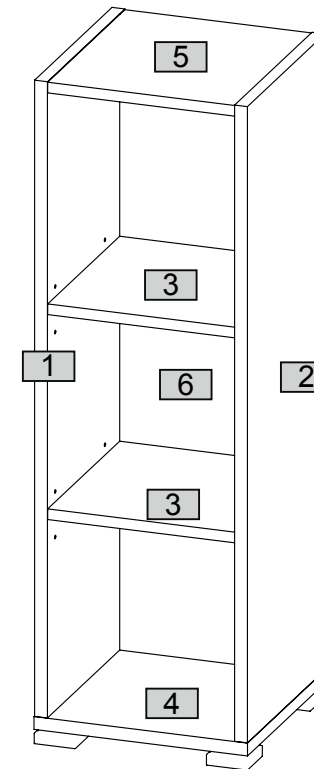

1

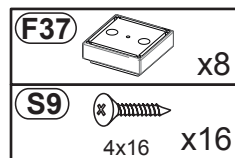
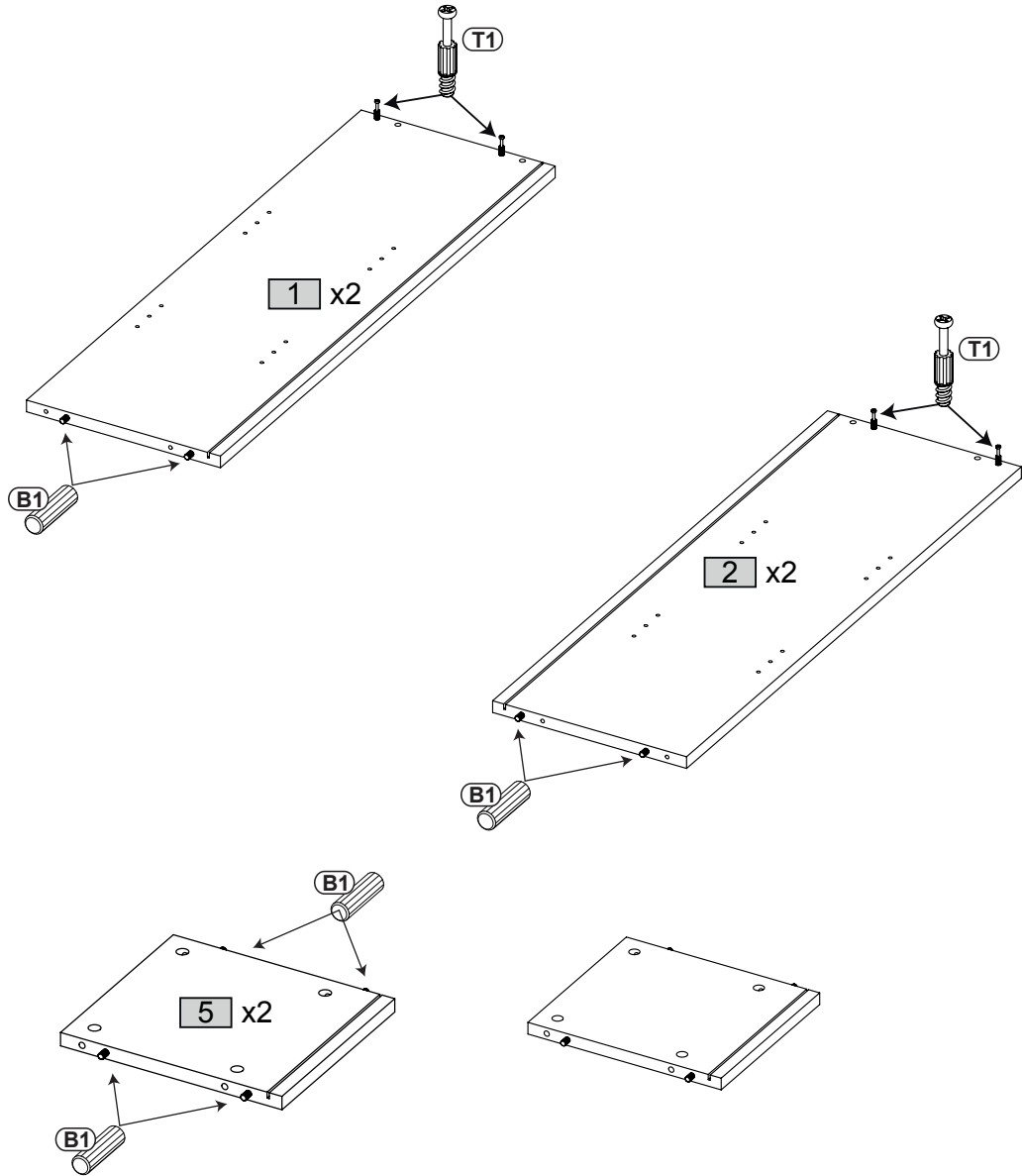
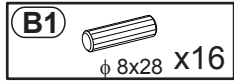
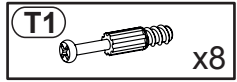

2



x2

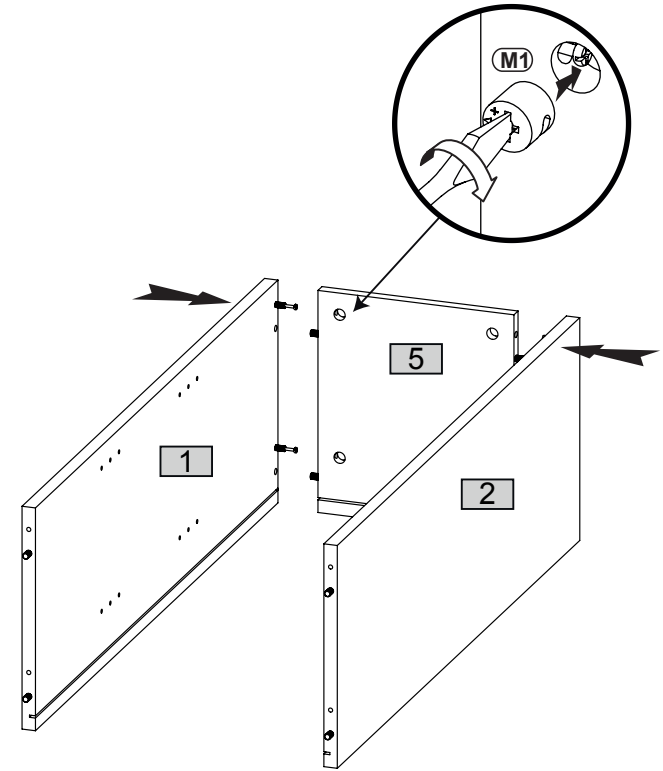

3

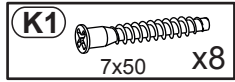

x2

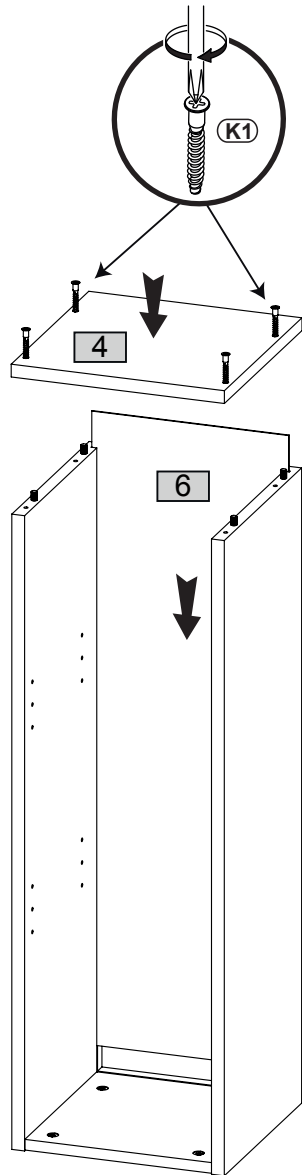

4

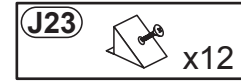
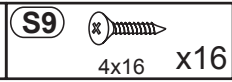
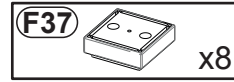

x2

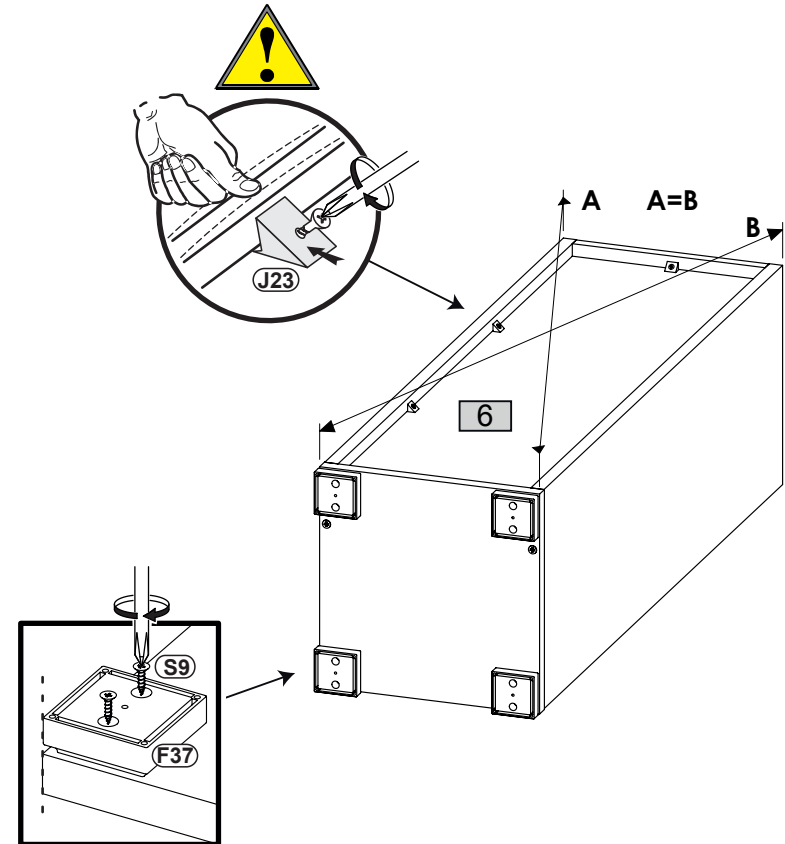

5

