

A	B	C1	C2	C3	D
1	L93-0051	953,	396	16	1/1
2	L93-0052	953,	396	16	1/1
3	L93-0053	200	596	16	1/1
4	L93-1055	942	410	16,	1/1
5	L93-1056	942	410	16,	1/1
6	L93-1057	942	390	16,	1/1
7	L93-1058	942	390	16,	1/1
8	L93-1059	145	373	12,	1/1
9	L93-2051	399,	430	16	1/1
10	L93-2052	1398	410	16	1/1
11	L93-2053	399,	430	16	1/1
12	L93-3060	601	390	16	1/1
13	L93-3061	365	390	16	1/1
14	L93-3062	599	348	6,	1/1
15	L93-4054	600	80	15	1/1
16	L93-4351	144	600	16	1/1
17	L93-9001	952	1375	2,5	1/1
18	WSP-9254	571	358	2,5	1/1
19	ZQ6-5040	561	127	15	1/1
20	ZQ6-511	350	140	12	1/1
21	ZQ6-512	350	140	12	1/1
22	L93-4055	601	60	15	1/1

- 2x n142
- 2x p17
- 4x p38
- 2x f35
- 6x c306
- 12x j30
- 6x k27
- 1x 670\9
- 8x p55
- 8x s2

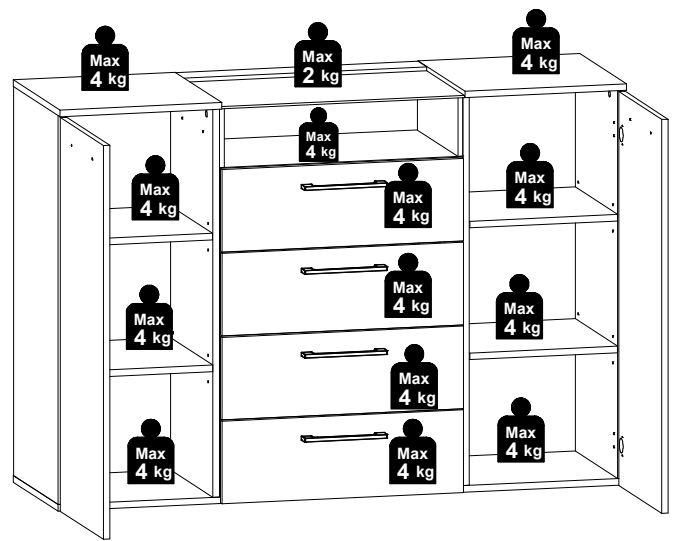

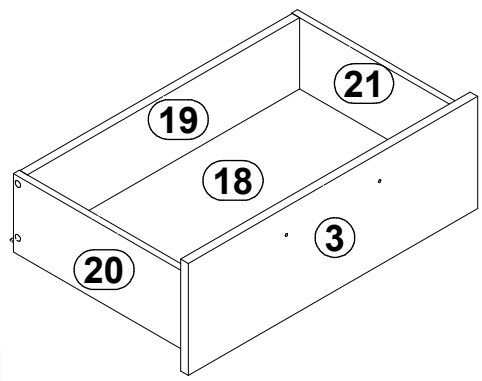

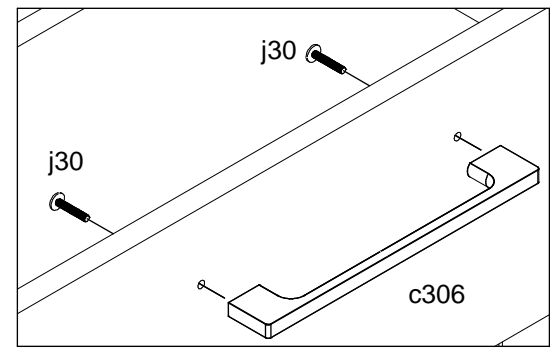
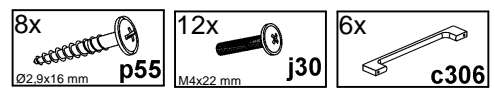
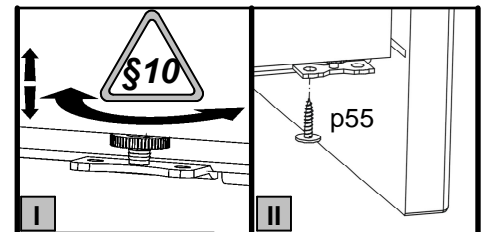
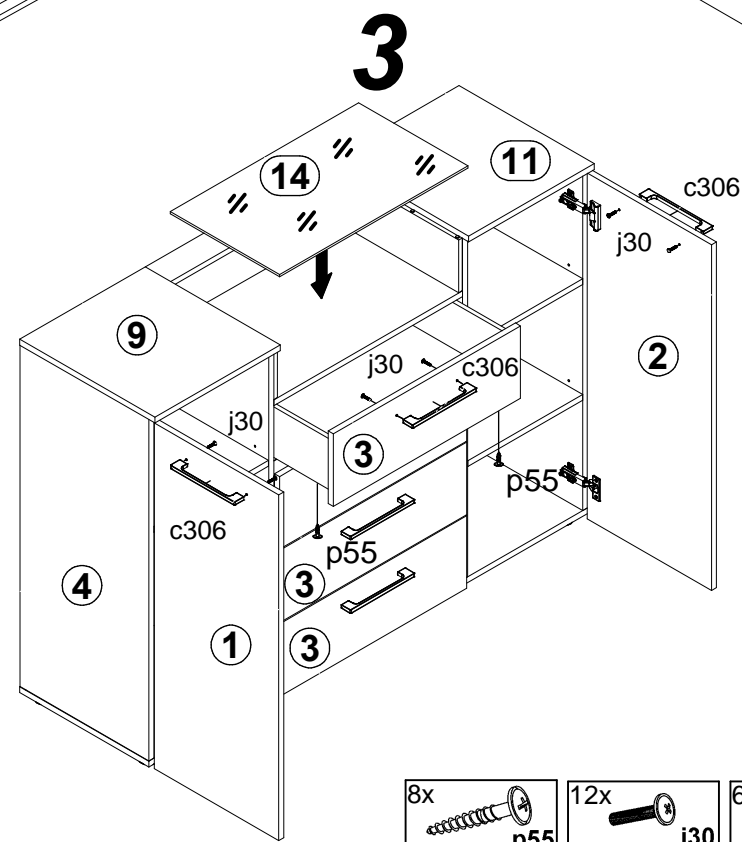
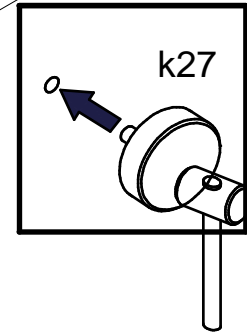
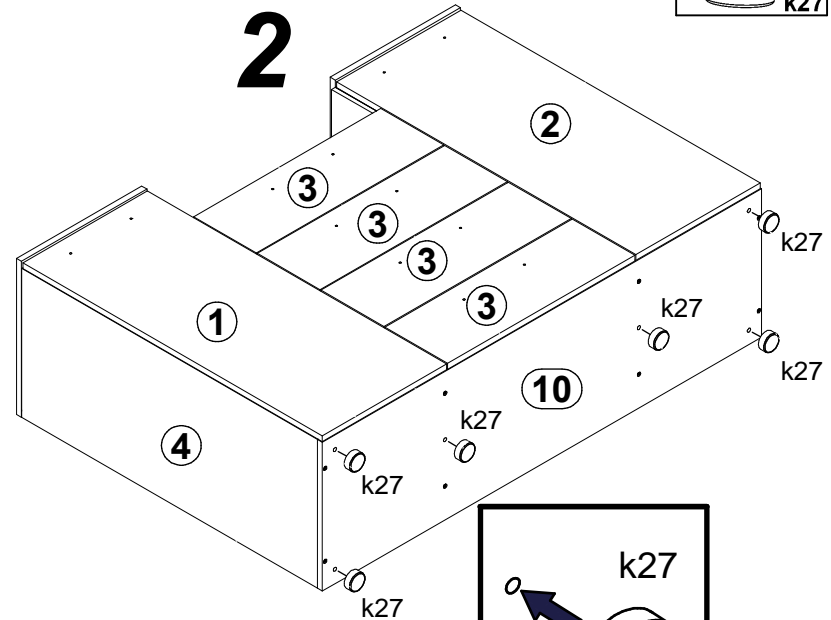
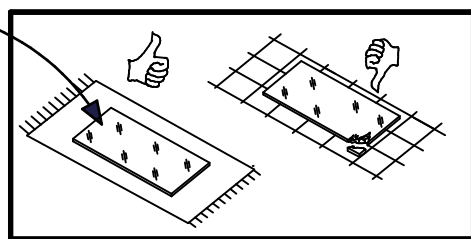
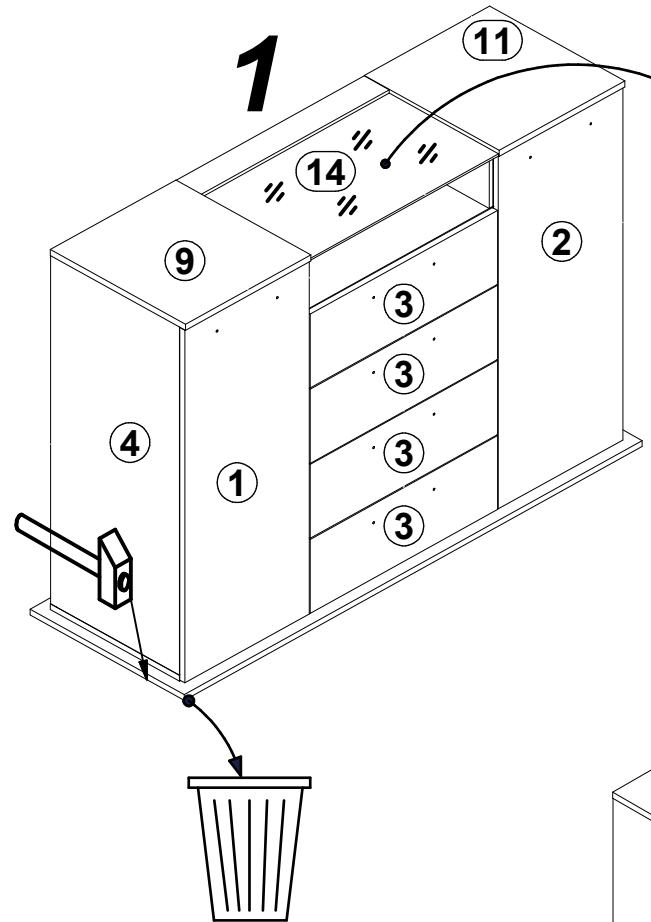
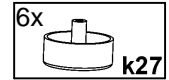
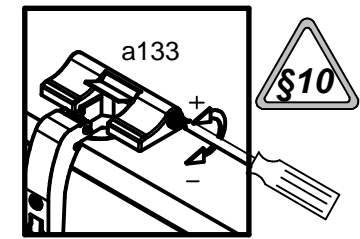
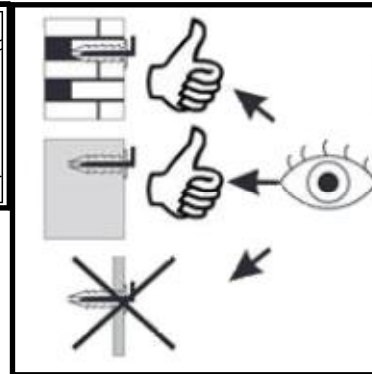
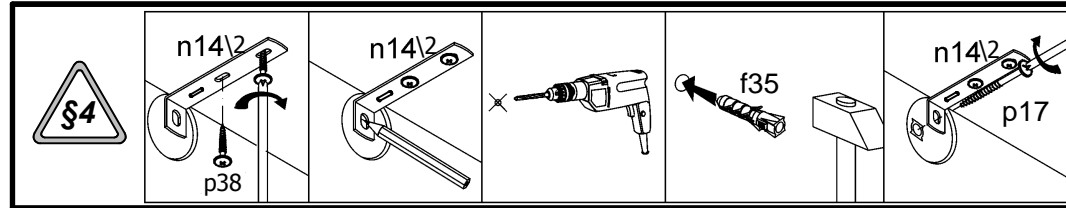

4

