

A	B	C	D	
1	F27-104	1950	580	1/3
2	F27-105	1950	551	1/3
3	F27-106	1853	485	1/3
4	F27-307	827	480	2/3
5	F27-310	1669	550	2/3
6	F27-311	1669	535	2/3
7	F27-405	1669	66	2/3
8	F27-406	1669	66	2/3
9	F27-902	1878	847	1/3

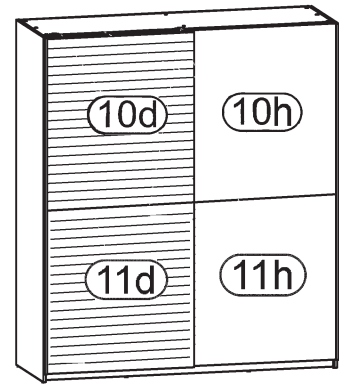

A	B	C	D	
10h	F27-507	950	861	3/3
10d	F27-507	950	861	3/3
11h	F27-508	950	861	3/3
11d	F27-508	950	861	3/3

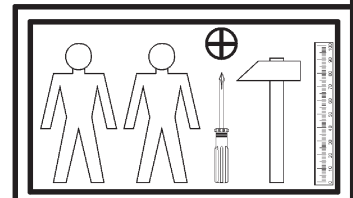
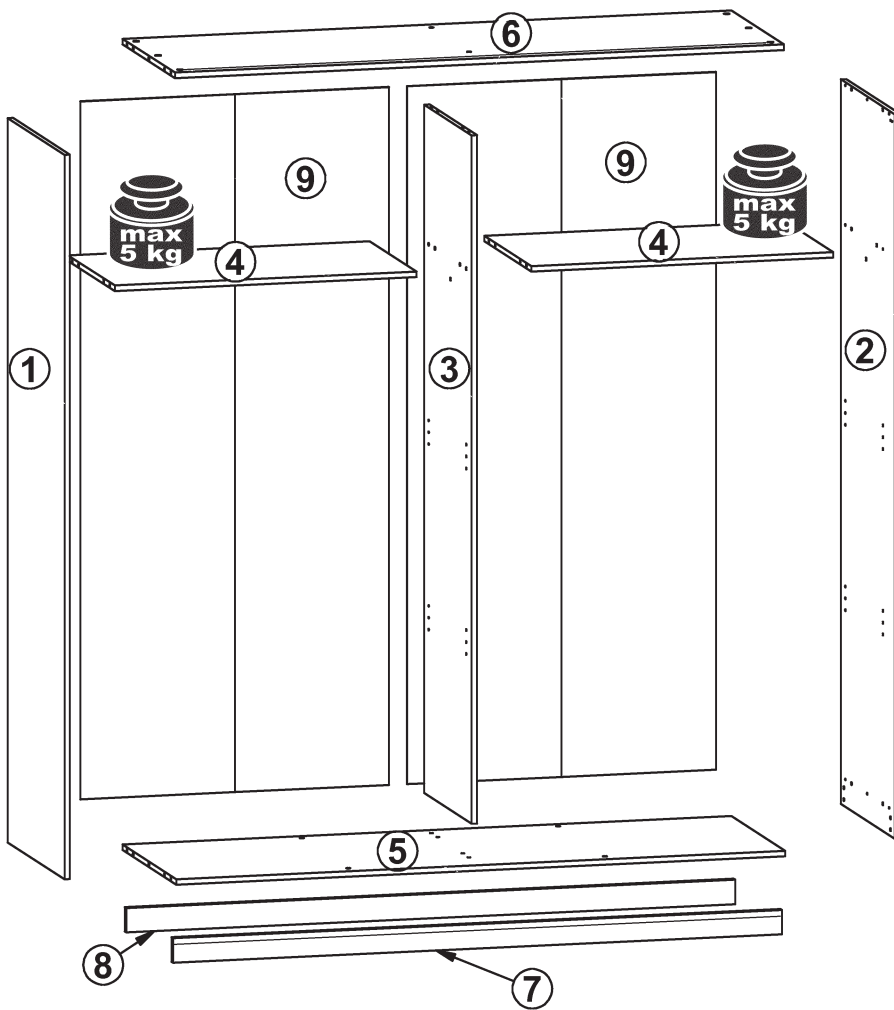

2x dr-821	8x e1 Ø7x50 mm	28x f1 Ø8x30 mm	2x f20	8x k1	50x l1	4x n1	2x n142	2x n143
1x n144	2x n146	2x n147	4x n76	2x n145	4x p16 Ø3.5x25 mm	32x p19 Ø4x16 mm	13x p25 Ø3.5x16 mm	79x p93 Ø4x13 mm
20x r1 Ø15x12 mm #16	2x r10	16x r42	9x n108 20x13x3.51	9x p55 Ø2.9x16 mm	2x w1183-AN 1900mm	2x w1184-AN 1900mm	1x w95\5 1668 mm	1x w96\5 1668 mm
1x z1	2x p60 Ø4x22 mm	4x s1	8x s2 Ø16					

**1** §2

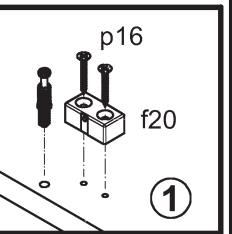
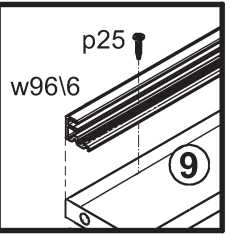
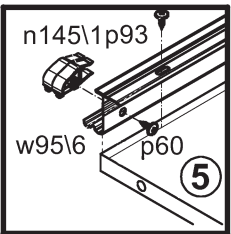
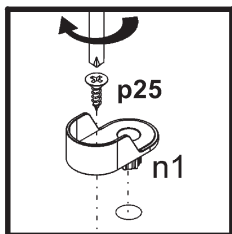
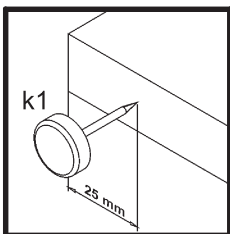
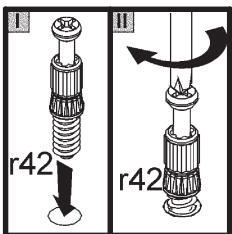
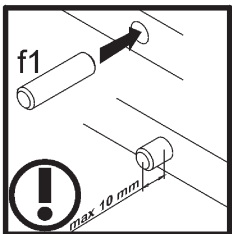
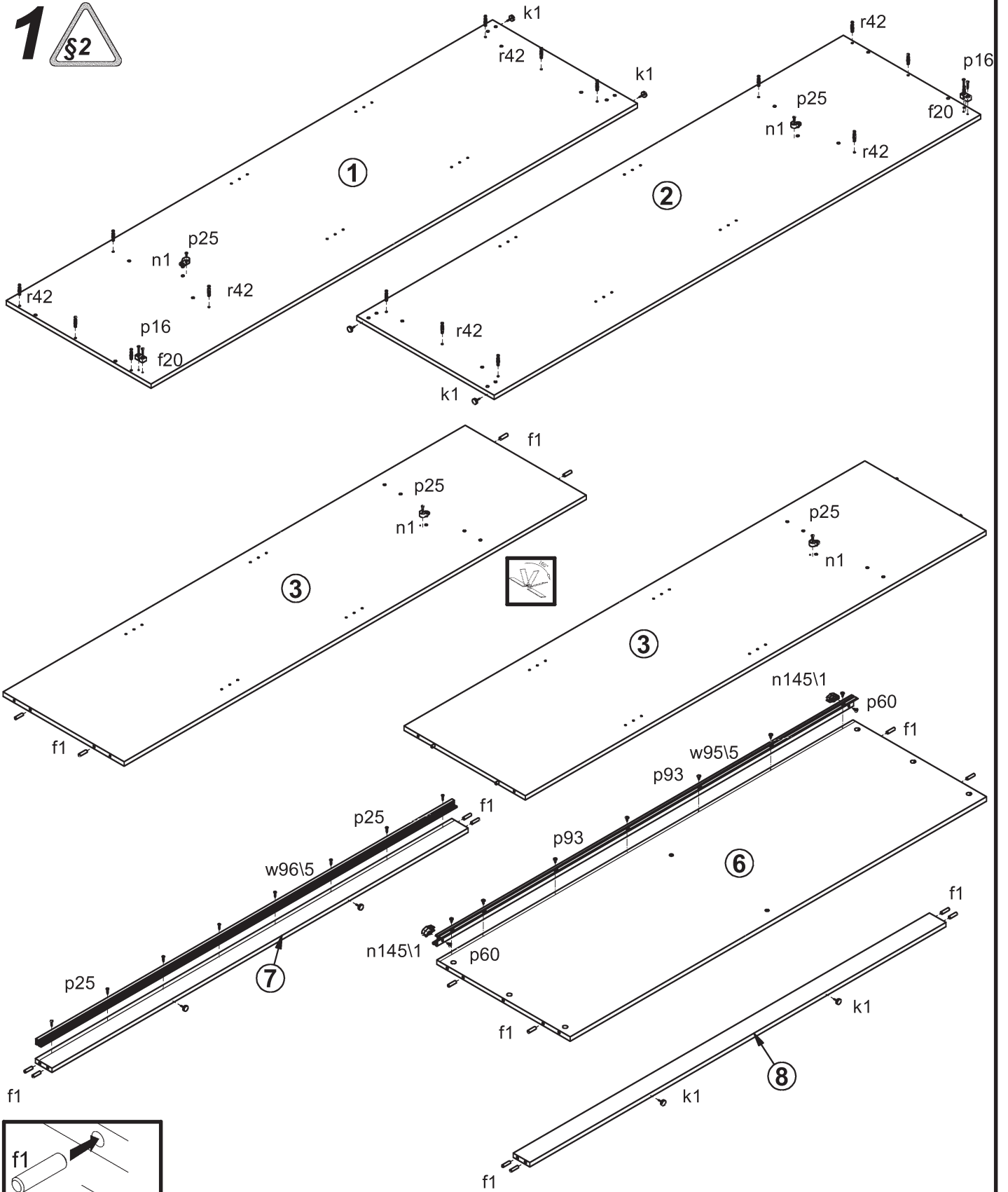

# 2

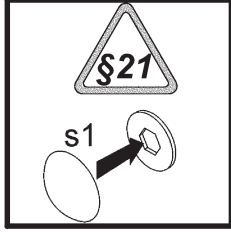
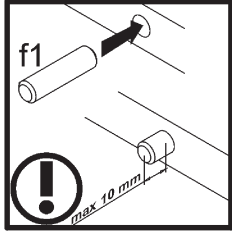
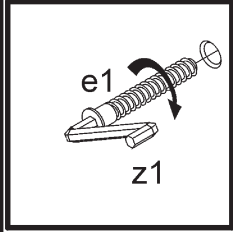
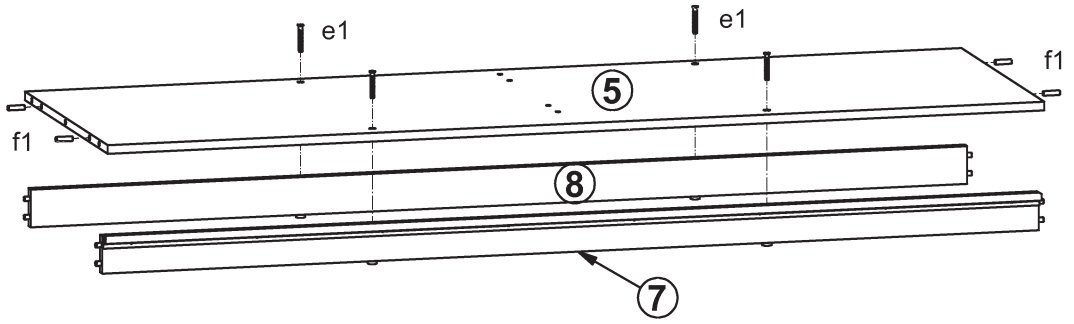

# 3

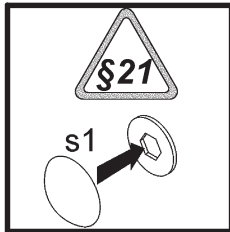
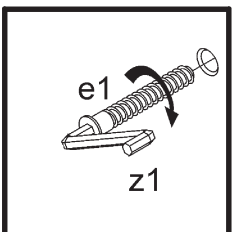
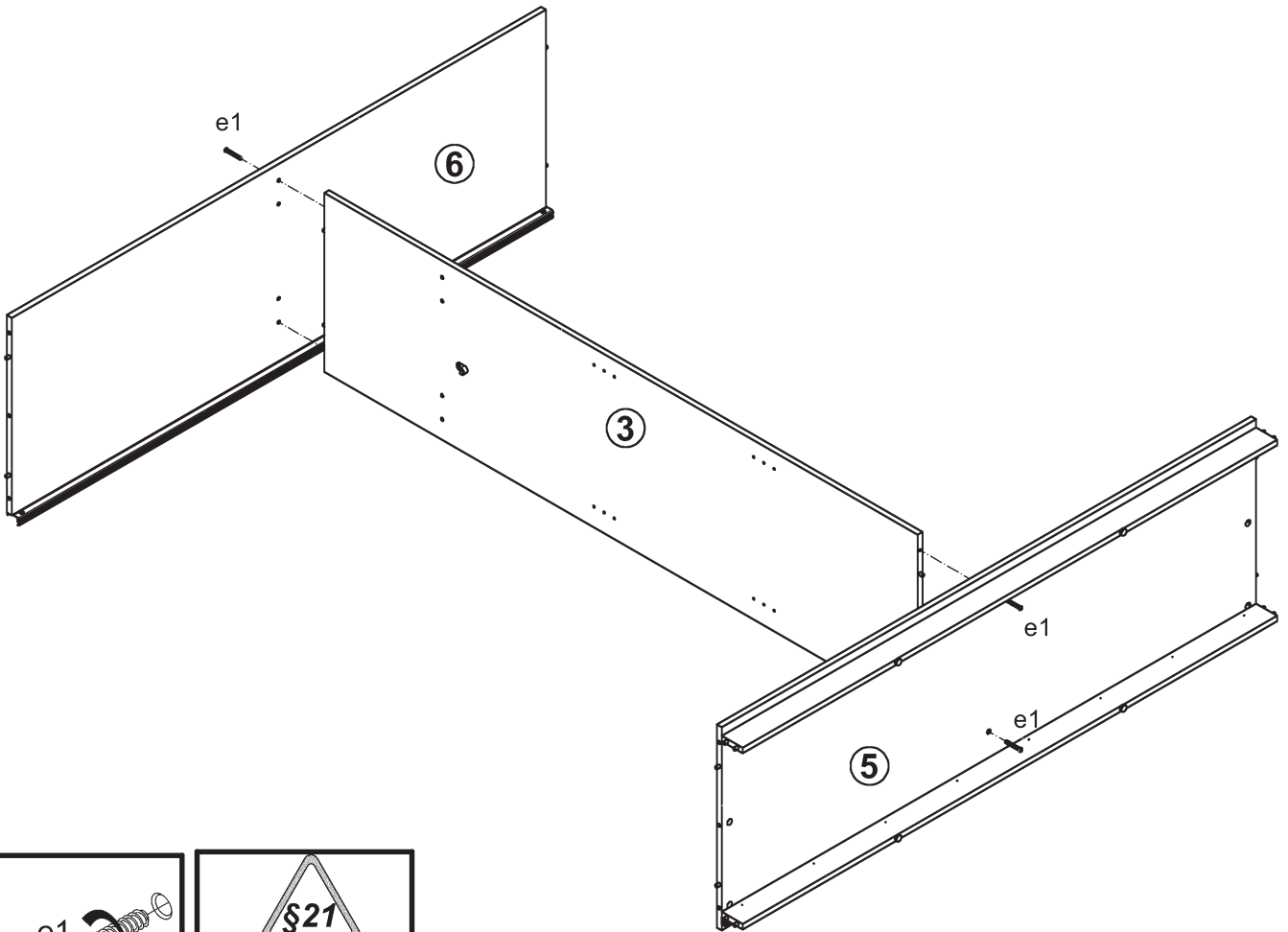

# 4

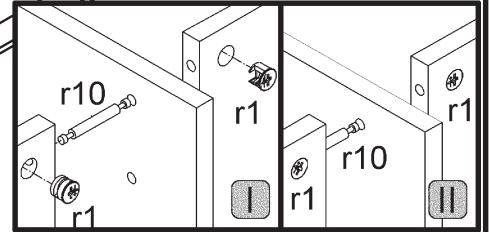
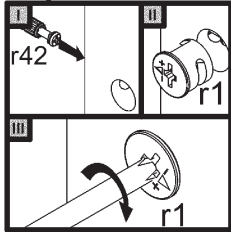
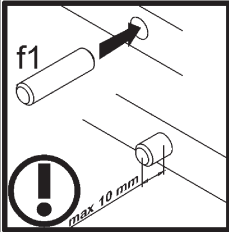
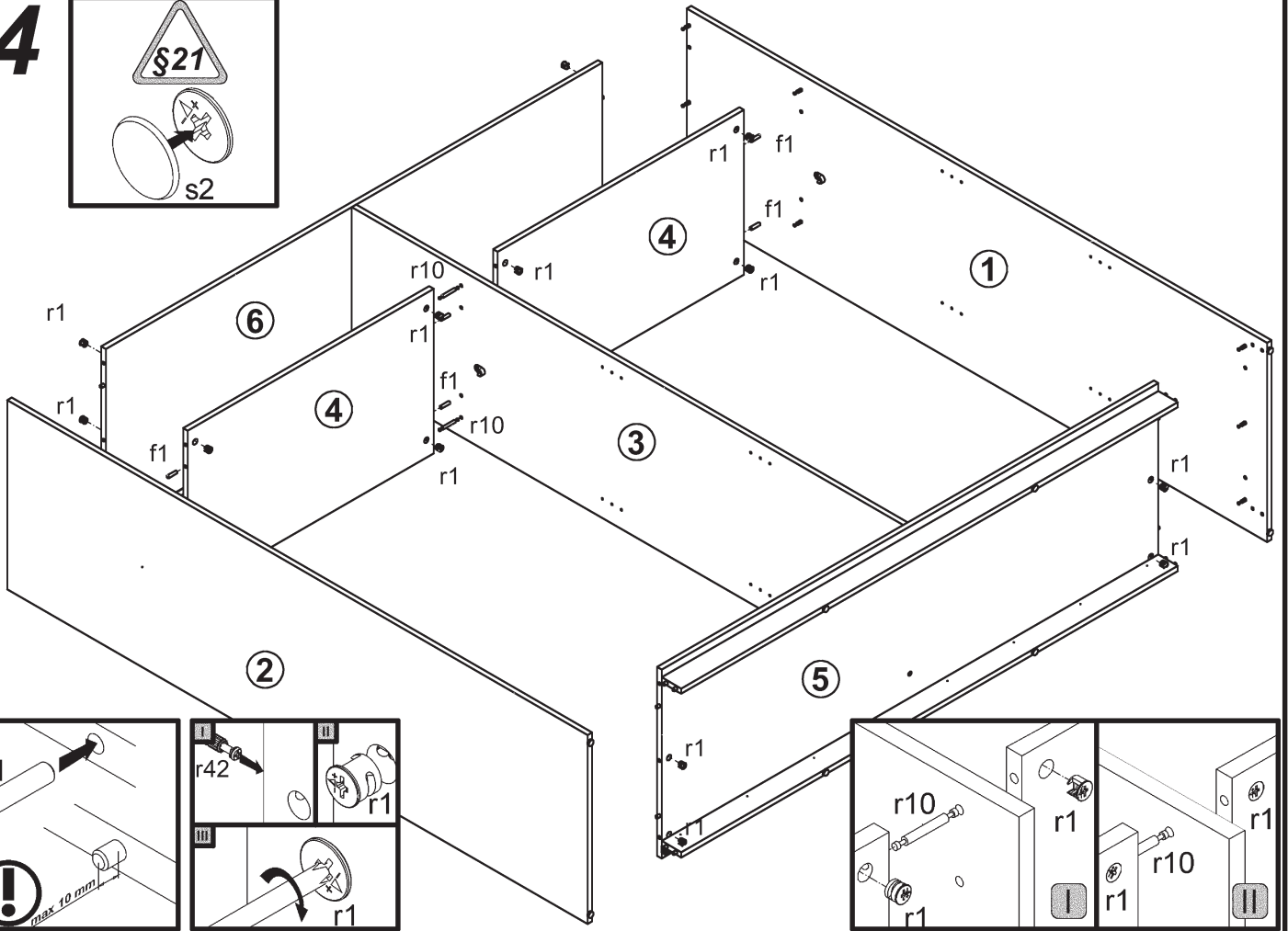
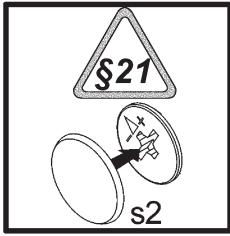

# 5

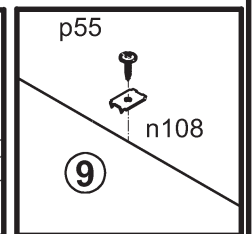
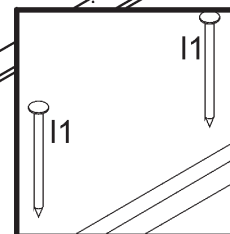
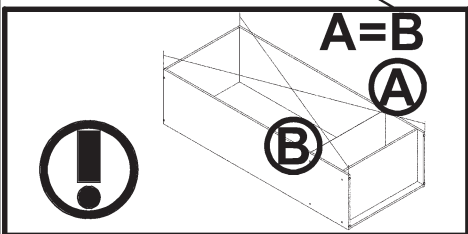
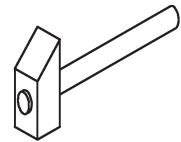
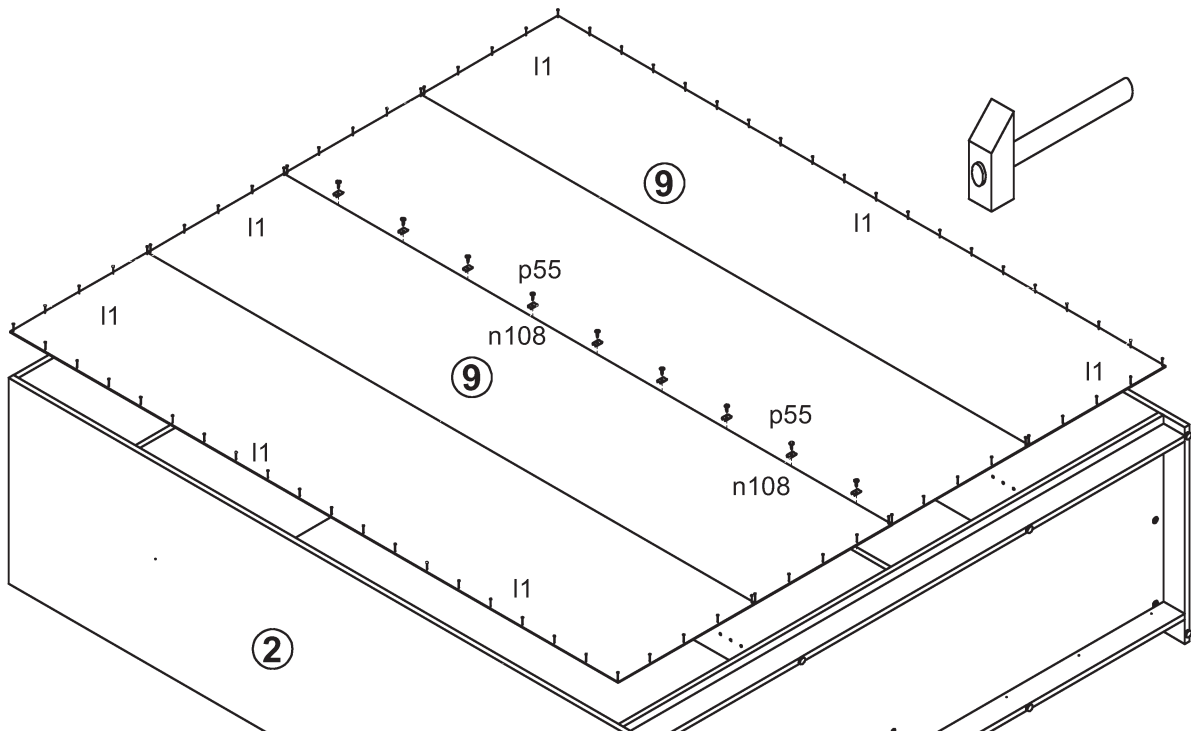

# 6

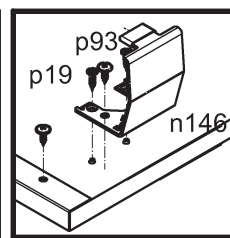
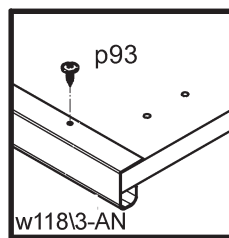
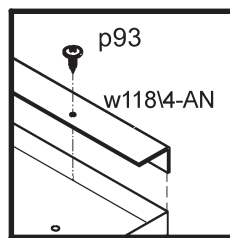
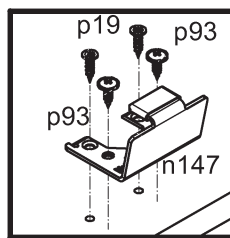
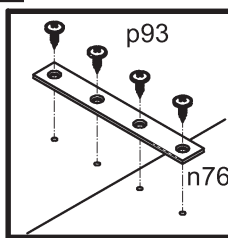
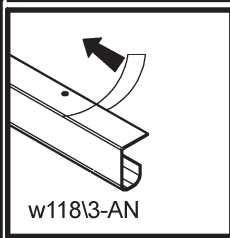
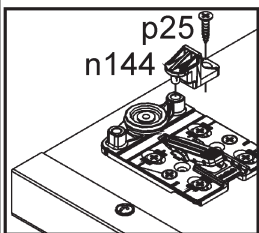
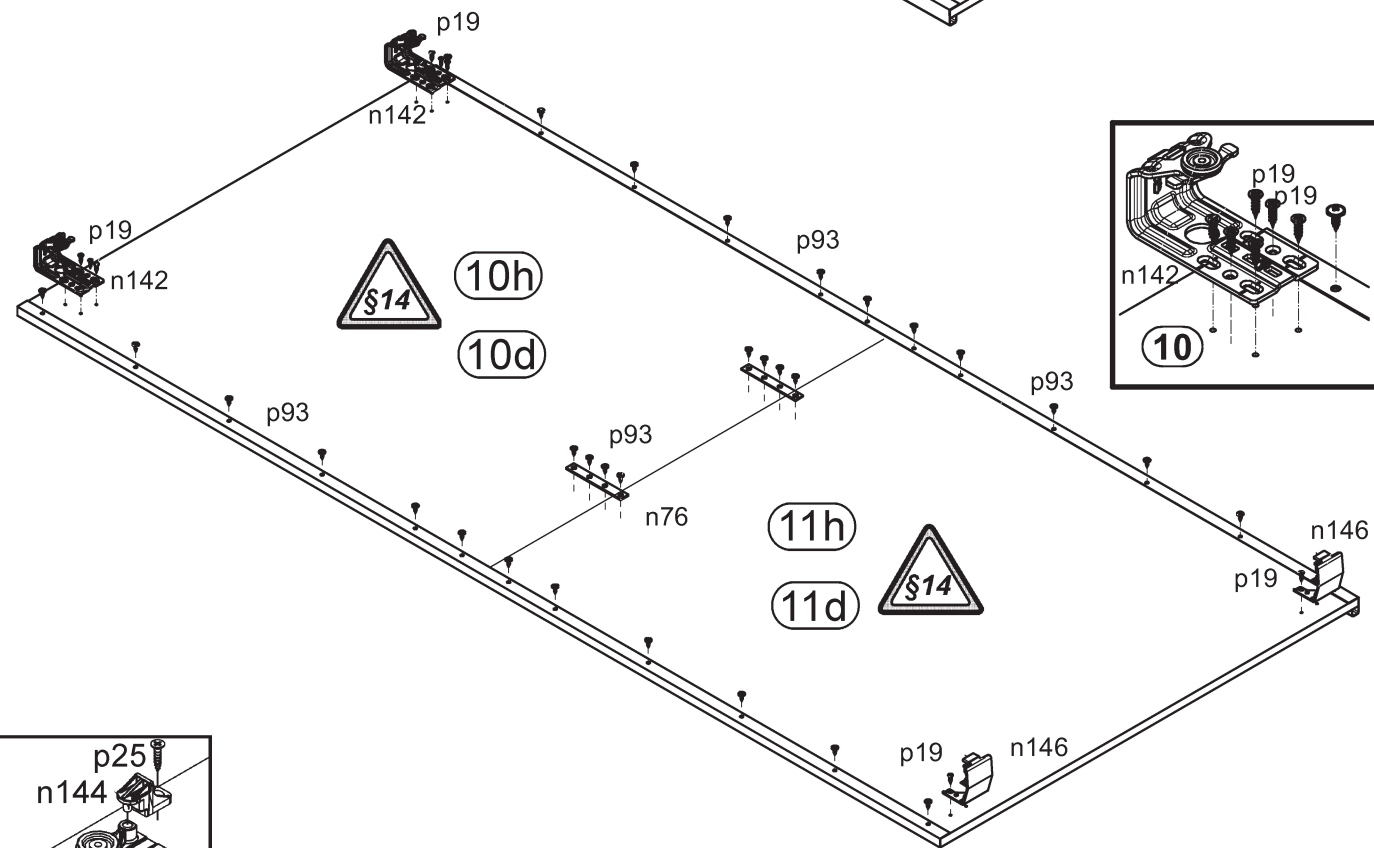
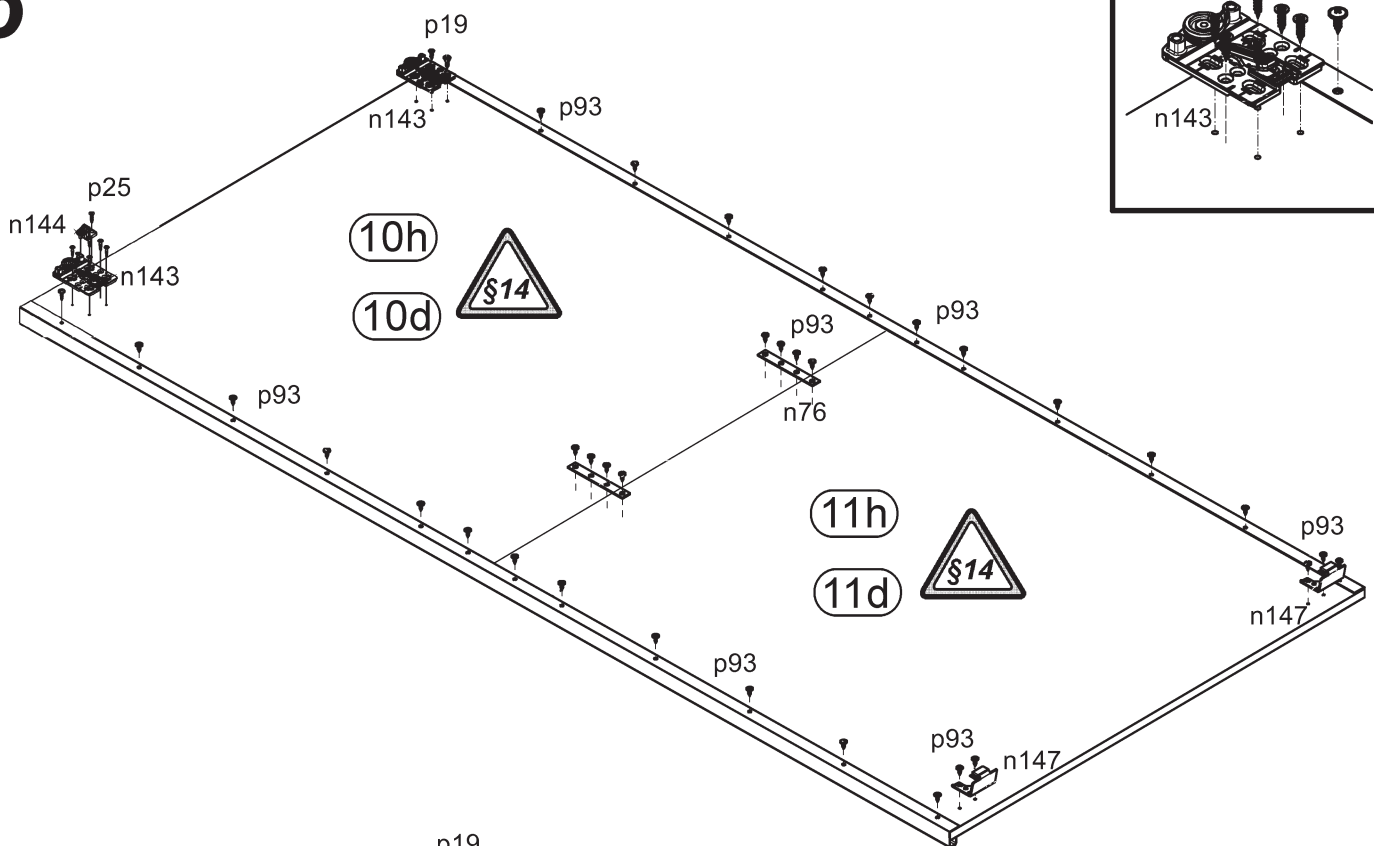

7

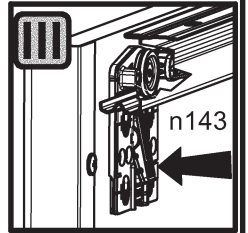
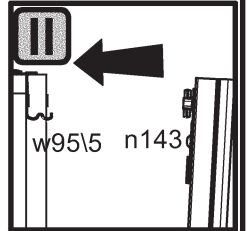
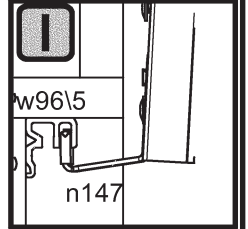
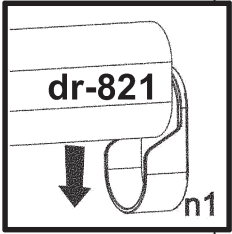
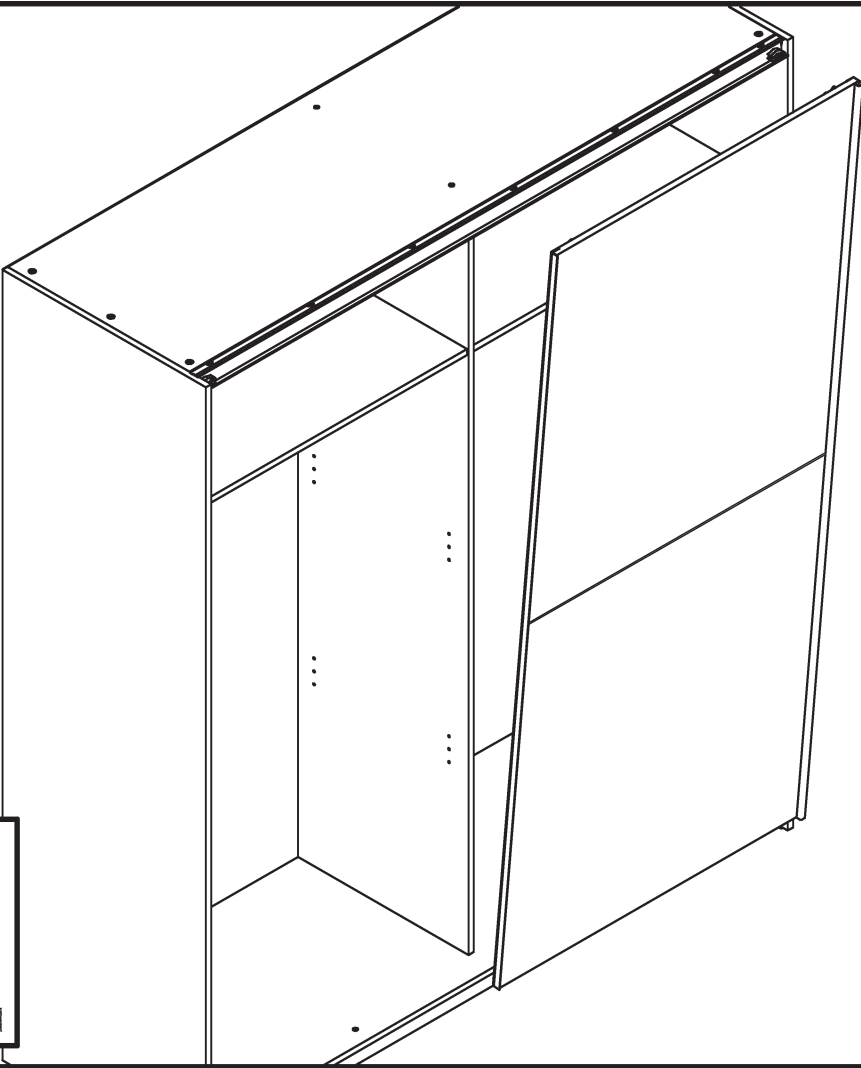

8

