

## Pio

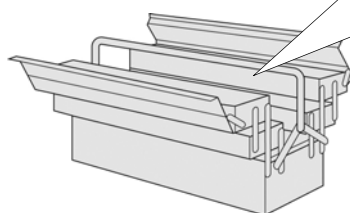

- |                                  |                                       |
|----------------------------------|---------------------------------------|
| <b>D</b> Montageanleitung        | <b>GB</b> Assembly instructions       |
| <b>FR</b> Notice de montage      | <b>NL</b> Handleiding voor de montage |
| <b>CZ</b> Montážní návod         | <b>IT</b> Istruzioni di montaggio     |
| <b>RO</b> Instrucțiuni de montaj | <b>RU</b> инструкция по сборке        |
| <b>PL</b> Instrukcja montażu     | <b>SK</b> Návod na montáž             |
| <b>HU</b> Szerelési útmutató     | <b>TR</b> Montaj talimatı             |

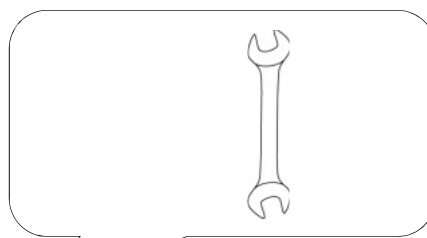

0  
10  
20  
30  
40  
50  
60  
70  
80  
90  
100  
110  
120  
130  
140  
150  
160  
170  
180  
190  
200

**ervice • Assistenza • Dienstverlening • Serwis  
Servis • Szerviz • Сервисная служба**

Name • Nom • Nome • Naam Nazwa • Jméno • Názov • Név Denumire • Ísim • Название	<b>Pio EB</b>
Nr. • No. • N° • Номер • Č • Sz	<b>SH55</b>
Typ • Type • Tip • Típus • Tipo Тип	<b>OHNE</b>

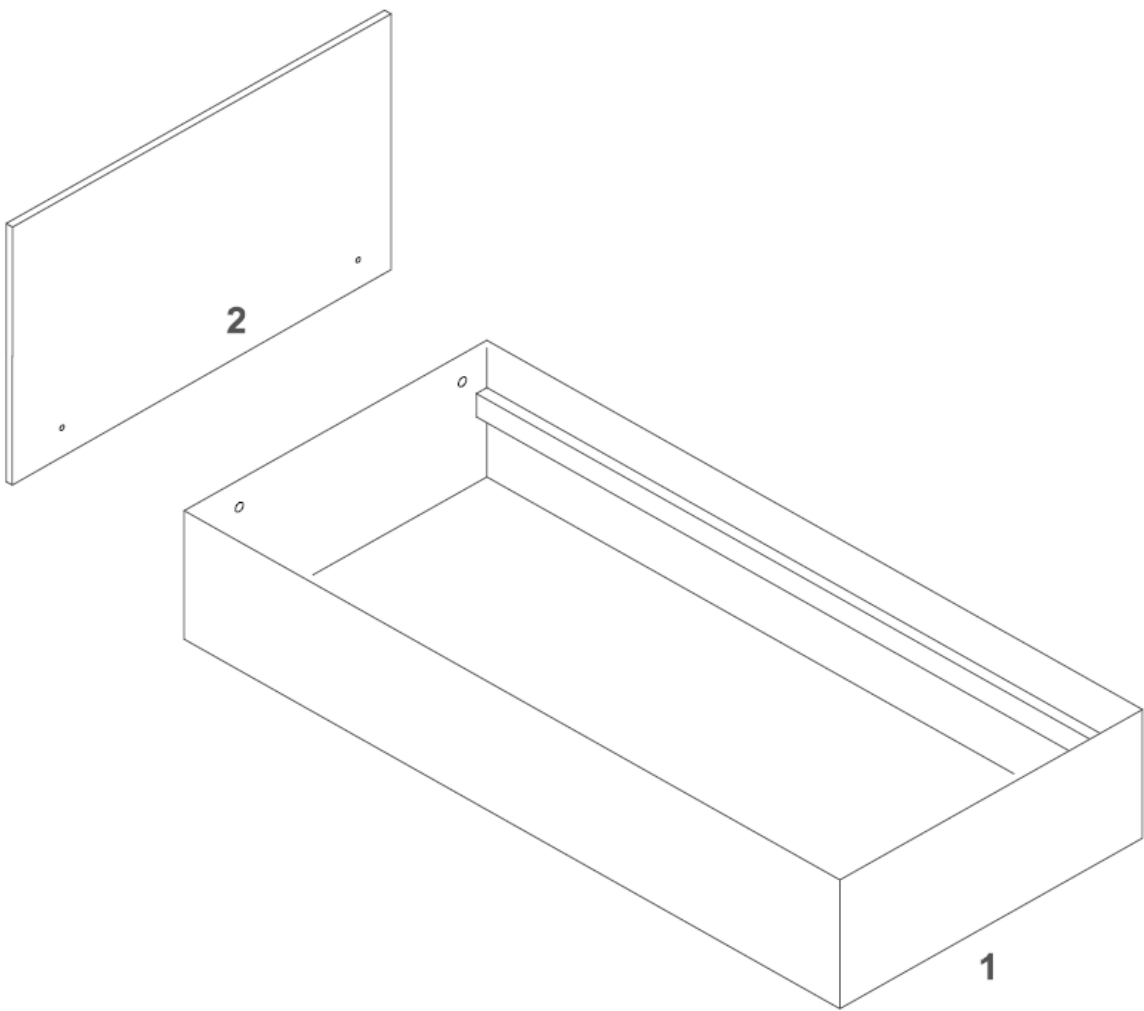
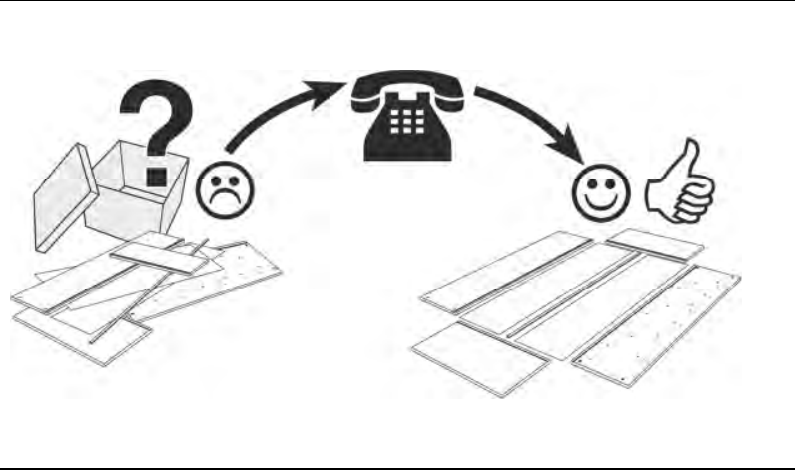
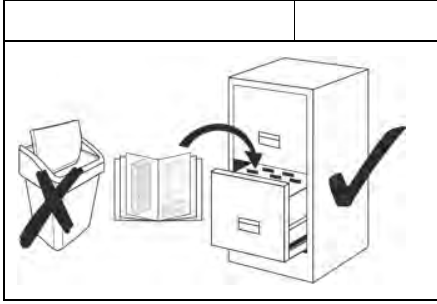

A	B	C	D
2x	4x 8x60	4x 8x40	4x M8

0  
10  
20  
30  
40  
50  
60  
70  
80  
90  
100  
110  
120  
130  
140  
150  
160  
170  
180  
190  
200

**Service • Assistenza • Dienstverlening • Serwis  
Servis • Szerviz • Сервисная служба**

Name • Nom • Nome • Naam Nazwa • Jméno • Názov • Név Denúire • Ísim • Название	<b>Pio EB</b>
Nr. • No. • N° • Номер • Č • Sz	<b>SH55</b>
Typ • Type • Tip • Típus • Tipo Тип	<b>LARO</b>

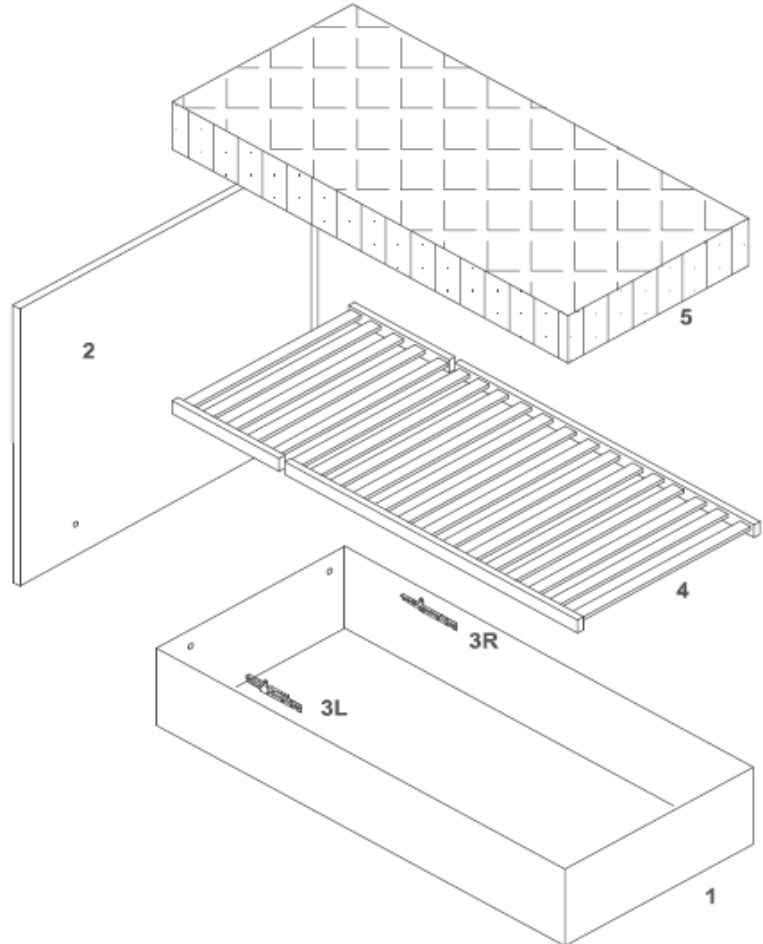
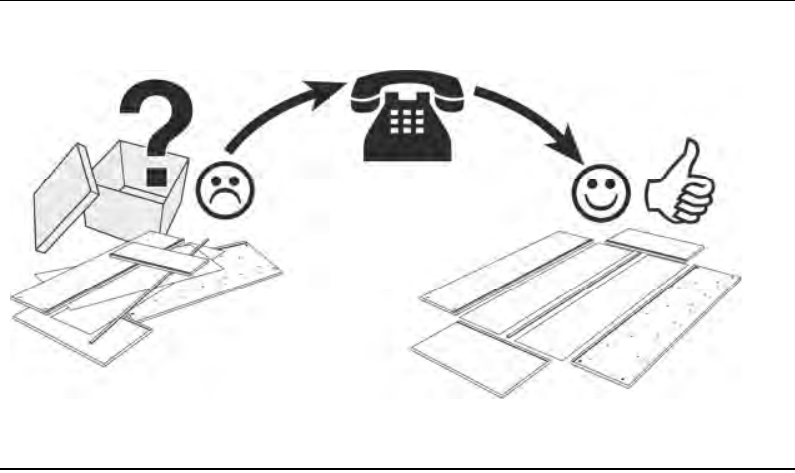
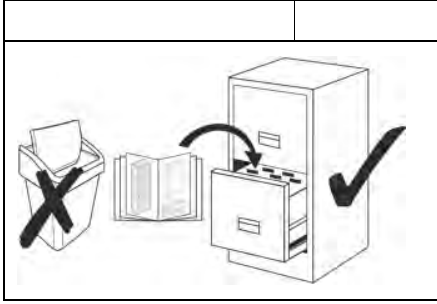

A	B	C	D
2x	4x 8x60	4x 8x40	4x M8

# Service • Assistenza • Dienstverlening • Serwis Servis • Szerviz • Сервисная служба

Name • Nom • Nome • Naam  
Nazwa • Jméno • Názov • Név  
Denumire • Ísim • Название

**Pio EB**





Nr. • No. • N° • Номер • Č • Sz

**SH55**

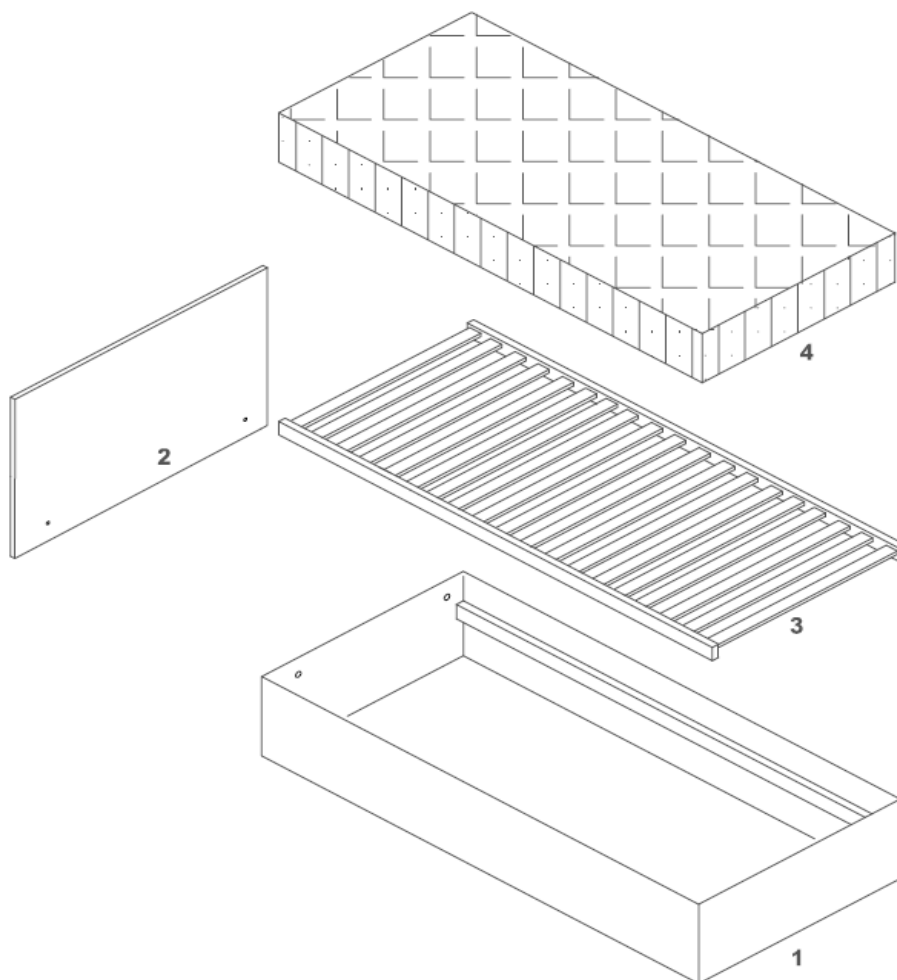
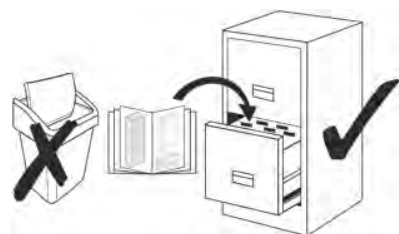
Typ • Type • Tip • Típus • Tipo  
Тип

**MOT**



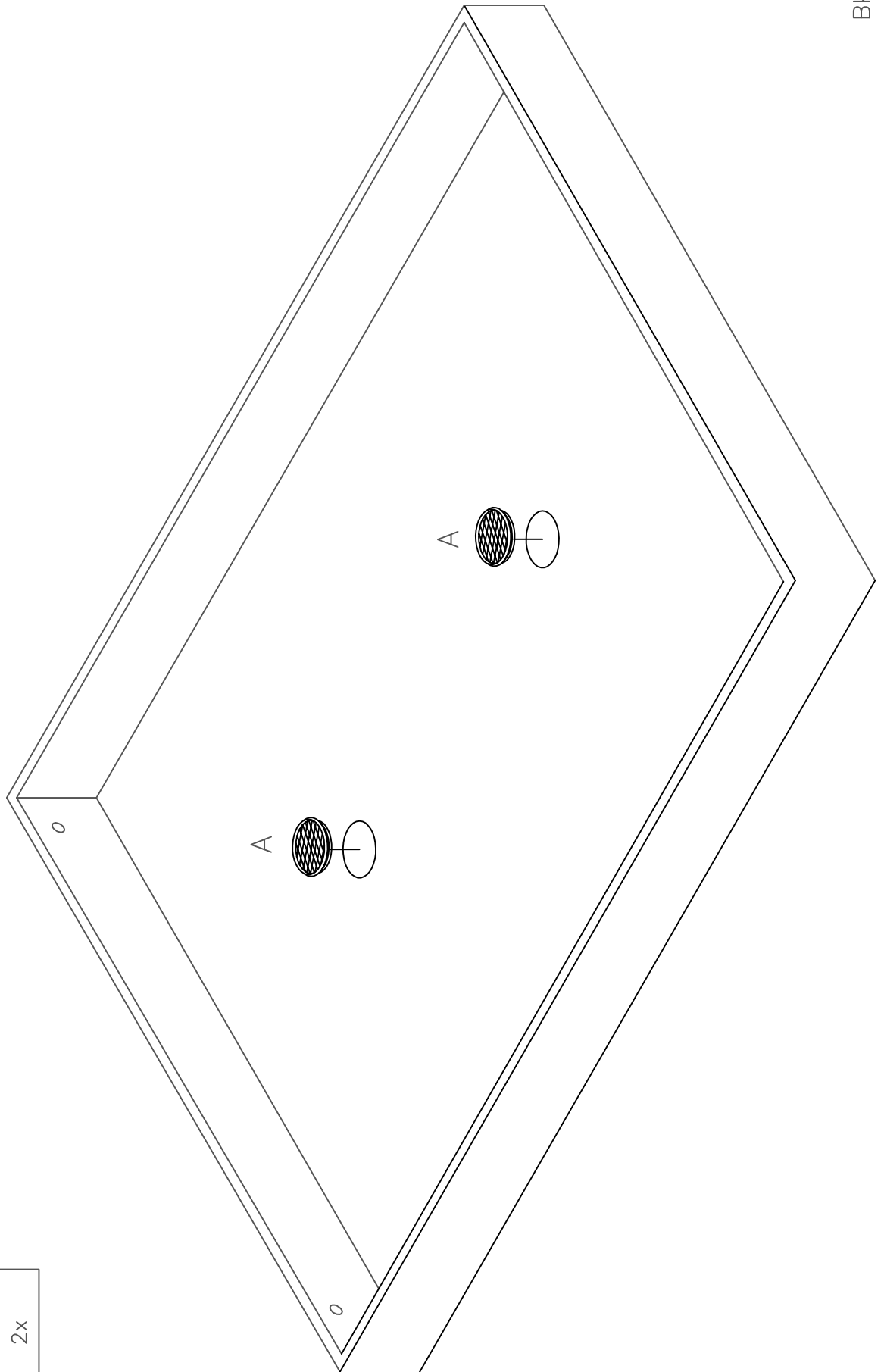

A	B	C	D
			
2x	4x 8x60	4x 8x40	4x M8

0  
10  
20  
30  
40  
50  
60  
70  
80  
90  
100  
110  
120  
130  
140  
150  
160  
170  
180  
190  
200



A		2x
---	---	----

2.

B	C	D	Achtung! Schrauben nicht überdrehen	GB Watch Out! Do not over tighten
			FR Attention! Ne serrez pas trop	NL Let Op! Niet te vast
4x 8x60	4x 8x40	4x M8	CZ Dávej Pozor! Nepřetahujte	IT Attento! Non stringere
			RO Ai Grija! Nu strângeji	RU Осторожно! Не затягивайте
			PL Uwaga! Nie dokręcać zbyt mocno	SK Dávaj Pozor! Nepretahujte
			HU Vigyázz! Ne húzza túl	TR Dikkat! Üzerinde sıkmayın

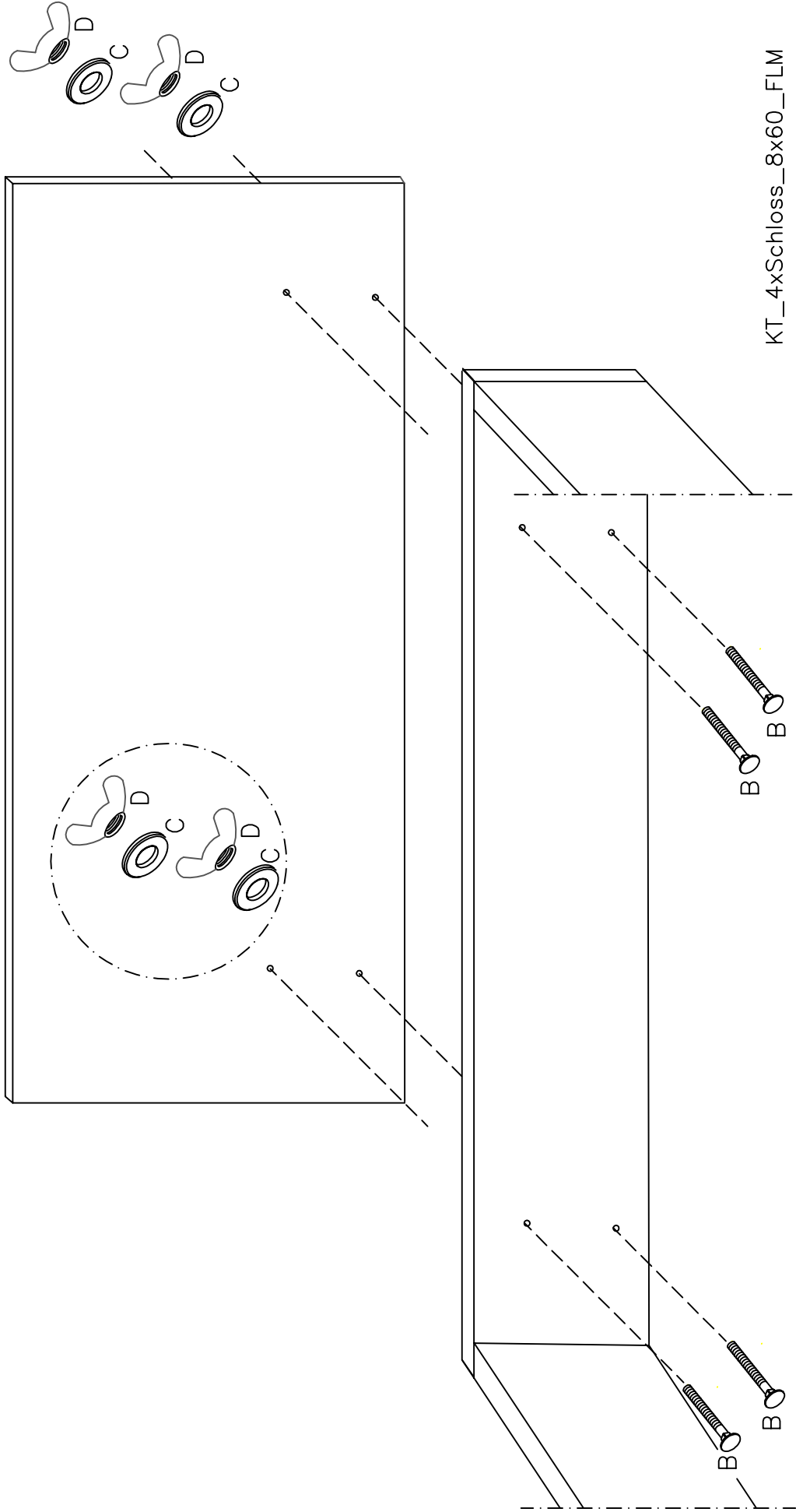

KT\_4xSchloss\_8x60\_FLM



Achtung! Den Motorrahmen nur bei geschlossenem Kopfteil verwenden.

Verletzungsgefahr !

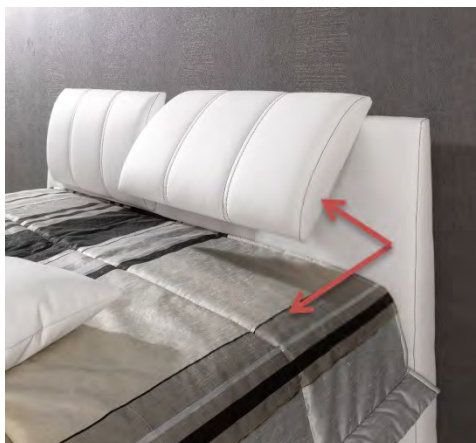

Attention! the motor frame only used for headboard closed Danger of injury!

Aandacht! het motorframe alleen gebruikt voor het hoofdeinde gesloten Gevaar voor letsel!

Внимание! двигатель рама используется только для изголовьем закрыт Опасность получения травмы!

Atenție! carcasa motorului utilizat numai pentru bordura închis Pericol de accidentare!

Uwaga! Rama silnika wykorzystywane wyłącznie do zagłówka zamknięty niebezpieczeństwo skaleczenia!

Attenzione! la carcassa del motore utilizzato solo per testata chiusa Pericolo di lesioni!

Attention! la carcasse du moteur utilisé uniquement pour tête de lit fermé Risque de blessure!

Pozor! rám motora slúži len pre čelo uzavretý Nebezpečenstvo úrazu!

Pozor!rám motoru slouží pouze pro čelo uzavřen Nebezpečí úrazu!

Figyelem! A motor keret csak a használt kopjafa zárt Sérülésveszély!

Dikkat! sadece başlık için kullanılan motorlu çerçeve yaralanma tehlikesi kapalı!