

NORDIC METALIC



- (DE) Montageanleitung
- (IT) Istruzioni di montaggio
- (PL) Instrukcja montażu
- (FR) Notice de montage
- (NL) Handleiding voor de montage
- (RO) Instrucțiuni de asamblare
- (GB) Assembly instructions
- (SK) Montážny návod
- (TR) Montaj talimatı
- (CZ) Montážní návod
- (RU) Инструкция по монтажу
- (HU) Szerelési útmutató



Service - Servis - Dienstverlening - Servis - Serwis - Сервисная служба - Servizio - Service
 Serviciu - Služby - Szolgáltatás

Name - Nazwa - Naam - Name - Isim - название
 Nome - Nom - Numele - Meno - Jméno - Neve

NORDIC METALIC



9 x (4x16) a	4 x M8 x 80 b	4 x Ø8 c	4 x M8 d	4 x (5x35) e	4 x 25mm 50mm x	6 x y	4 x z
2 x 13 cm w					2 x 1	2 x 2	

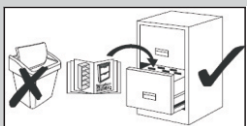
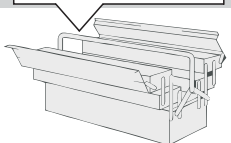
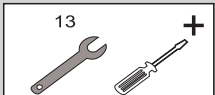
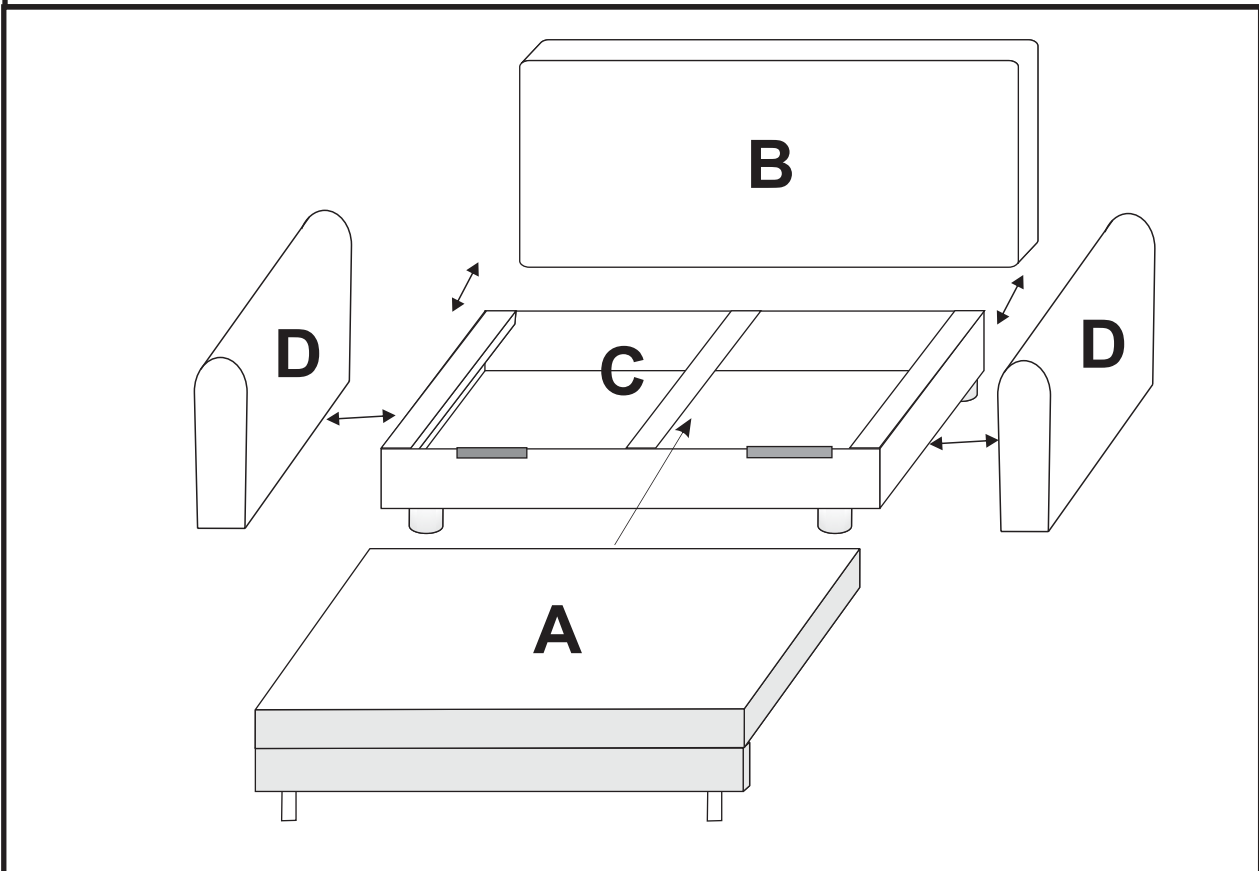

1

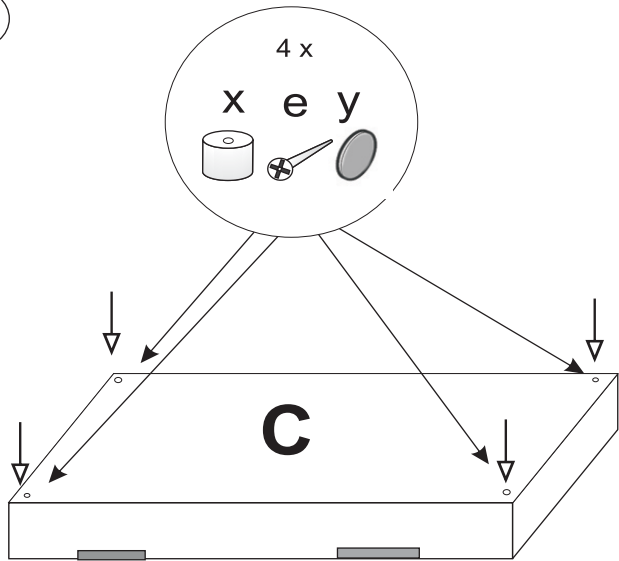

2

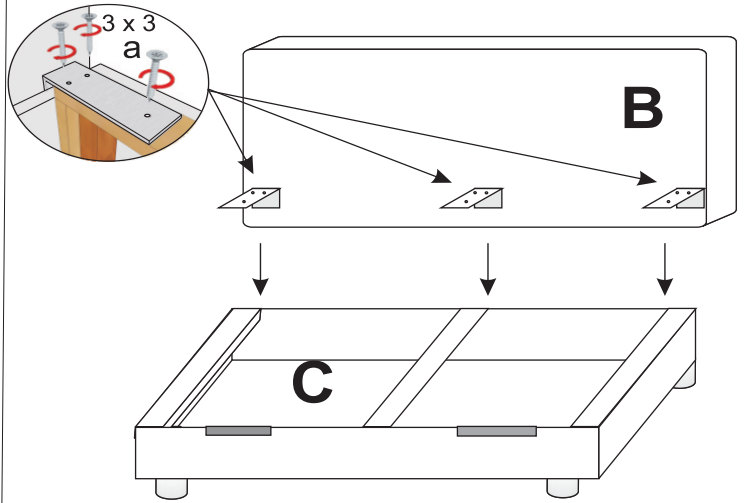

4

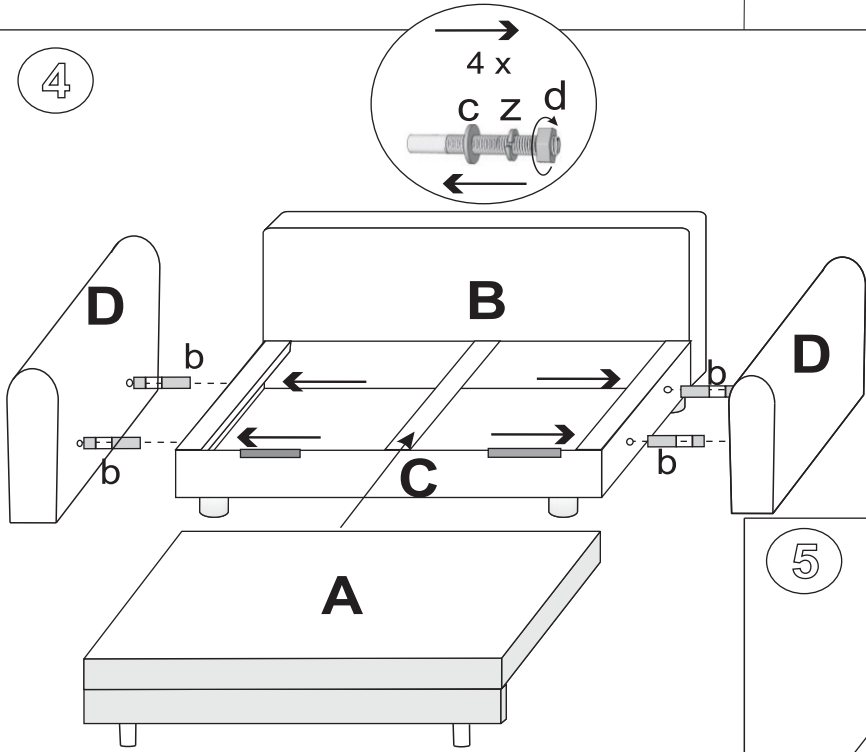

3

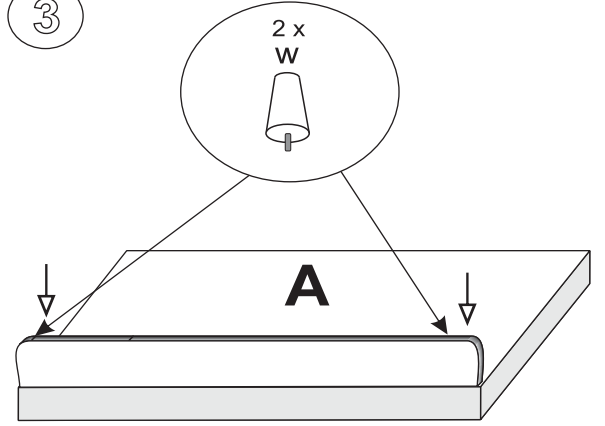

5

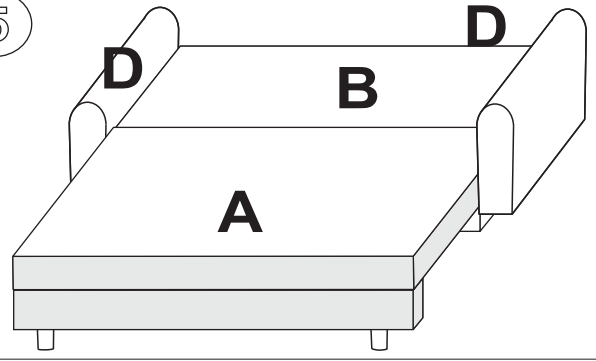

6

